

Article number: 20806311116P
Description: E+G Thrust pad
GN 6311.1-16-P

Measures

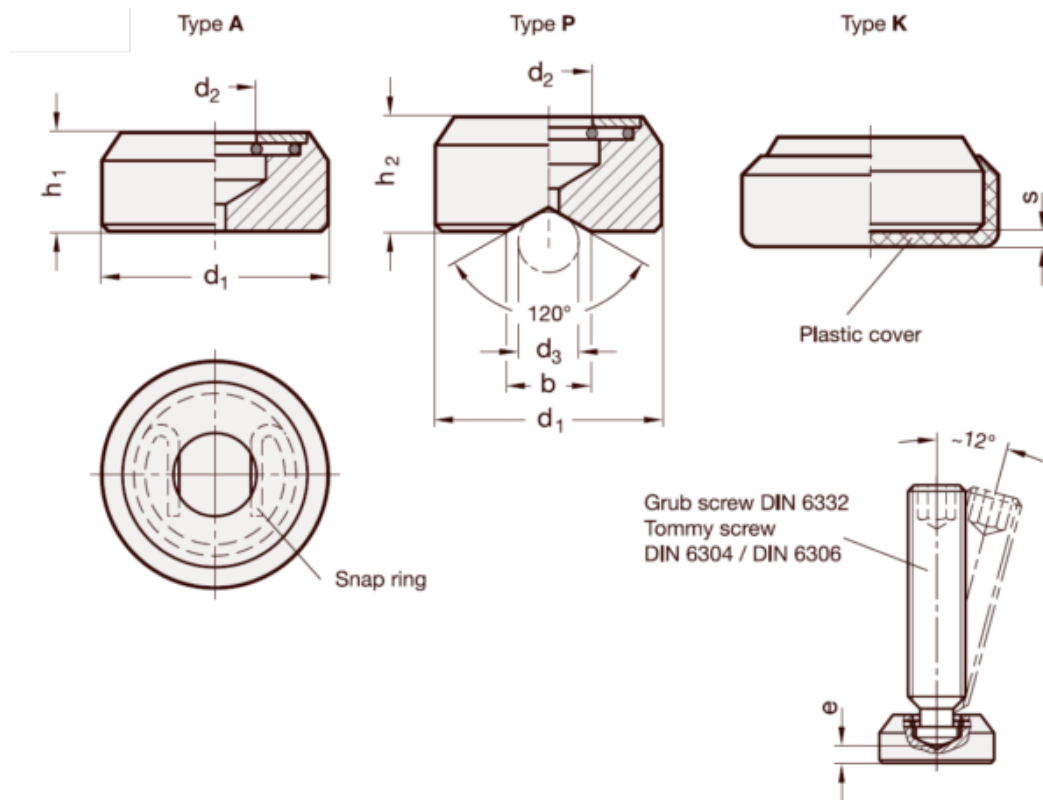

b = 10
d1 = 16
d2 = 6.3
d3 = 20
h2 = 11
Thread = M8
Type = Type P